

**ACT**  
**events**  
don't just exhibit. excite

**“We are the  
change  
that we seek”**

*Barack Obama / Super Tuesday Speech*  
Chicago, 5th February 2008

**ACT**  
**series**  
spazi creativi

**new ideas** and solutions

act-events.it

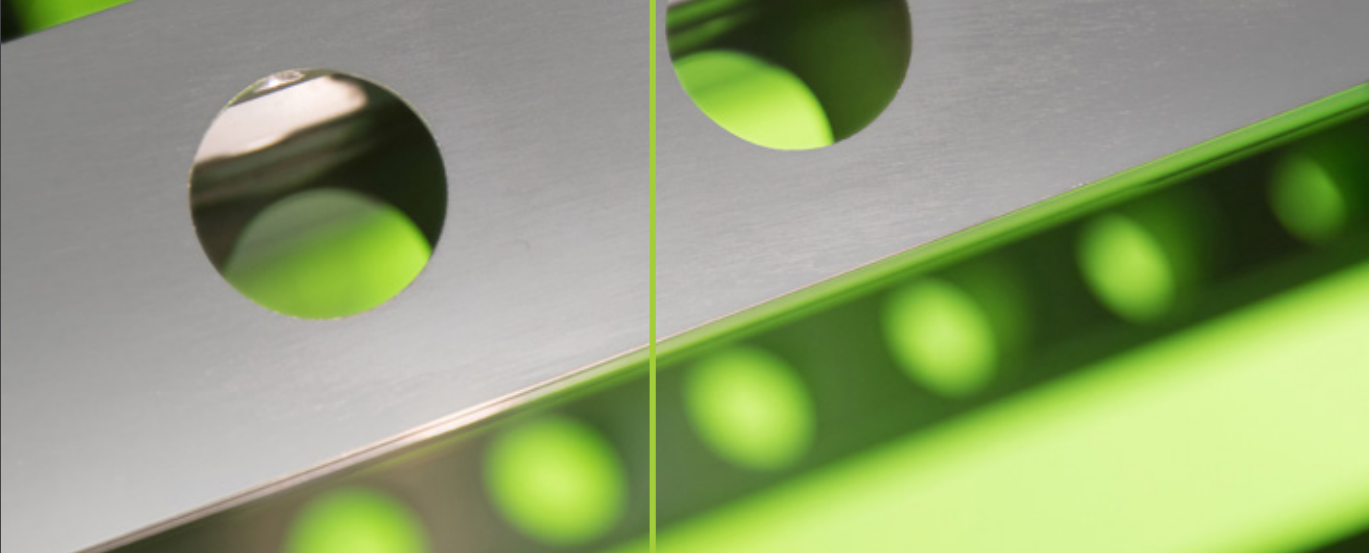

**ACT SERIES** è una  
linea di prodotti del  
gruppo **ACT EVENTS**

LA LINEA NASCE DALL'IDEA  
DI ADATTARE LE STRUTTURE  
E I MATERIALI PROPRI DELLE  
ARCHITETTURE TEMPORANEE  
ALLE ESIGENZE DI UFFICI,  
POSTAZIONI DI LAVORO ED  
EVENTI OPEN HOUSE.

### **SICURO**

PERMETTE DI SEPARARE  
AMBIENTI E GARANTIRE  
IL RISPETTO DELLE  
DISTANZE

### **ELEGANTE**

LINEA PULITA ED ESSENZIALE

### **MODULARE**

FLESSIBILE E FACILE DA MONTARE

### **SOSTENIBILE**

MATERIALI E TECNOLOGIE  
GREEN

### **LUMINOSO**

DISPONIBILE LA VERSIONE CON  
IMPIANTO A LED INTEGRATO



È UN MARCHIO  
ACT EVENTS SRL



## SERIE LINEA

MODULO SINGOLO

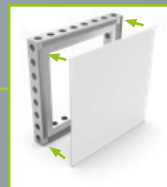

FISSAGGIO DEL PANNELLO RIGIDO ALLA CORNICE IN ALLUMINIO TRAMITE VELCRO



FISSAGGIO DEL TESSUTO ALLA CORNICE IN ALLUMINIO TRAMITE GOMMINO IN SILICONE

## CONFIGURAZIONI

LINEA 100

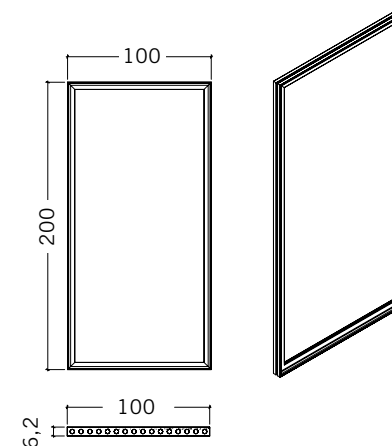

LINEA CUSTOM

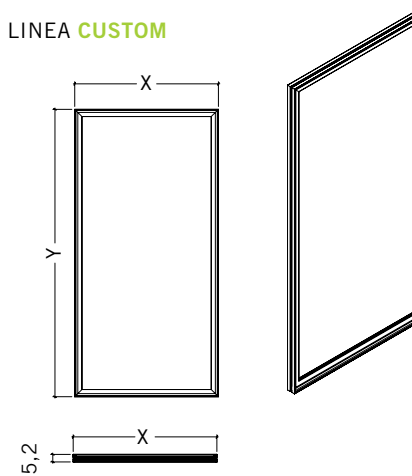

ALLUMINIO: LEGGERO, RESISTENTE E DUREVOLE.  
IN UNA PAROLA: **SOSTENIBILE.**

## SERIE TALETE MODULARE



## CONFIGURAZIONI

### TALETE SINGOLA

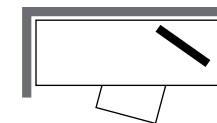

### TALETE DOPPIA

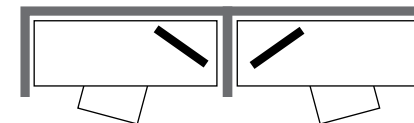

### TALETE DOPPIA FRONTALE

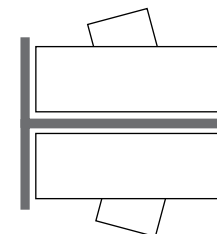

### TALETE QUADRUPLA

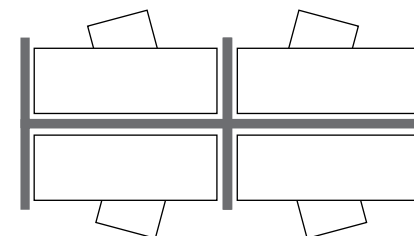





**SERIE LUCE**  
MODULO COMPOSTO

**CONFIGURAZIONI**

LUCE **BASE**

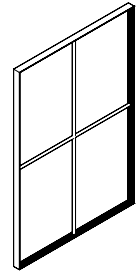
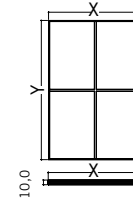

LUCE **L**

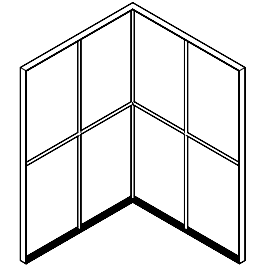
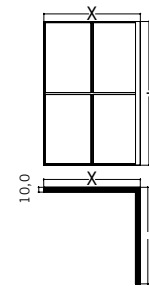

LUCE **U**

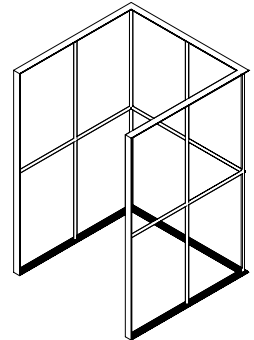
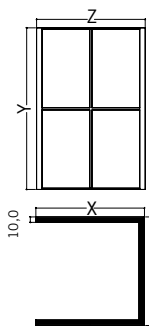

STAMPA SUBLIMATICA SU TESSUTO: SENZA SOLVENTI,  
DURATURA, RICICLABILE. IN UNA PAROLA: **ECOLOGICA.**



**SERIE ARCO**  
MODULO COMPOSTO

**CONFIGURAZIONI**

**SERIE QUADRO**  
MODULO COMPOSTO



STRUTTURA



STRUTTURA RIVESTITA

The possibilities are **endless.**

**CONTATTACI** PER UNA SOLUZIONE SU MISURA PER IL TUO UFFICIO,  
MAGAZZINO, PUNTO VENDITA O EVENTO OPEN HOUSE



**SEDE LEGALE**

**ACT EVENTS SRL**  
VIA FILIPPO TURATI 6/D  
40057 QUARTO INFERIORE (BO), ITALY  
P.IVA/COD.FISC IT02924421205

**CONTATTI**

T. +39 051 768202  
[marketing@act-events.it](mailto:marketing@act-events.it)



[act-events.it](http://act-events.it)

IN COLLABORAZIONE CON

